

MSA-600 Micro System Analyzer

Measuring 3D dynamics and topography
of MEMS and microstructures

Product brochure

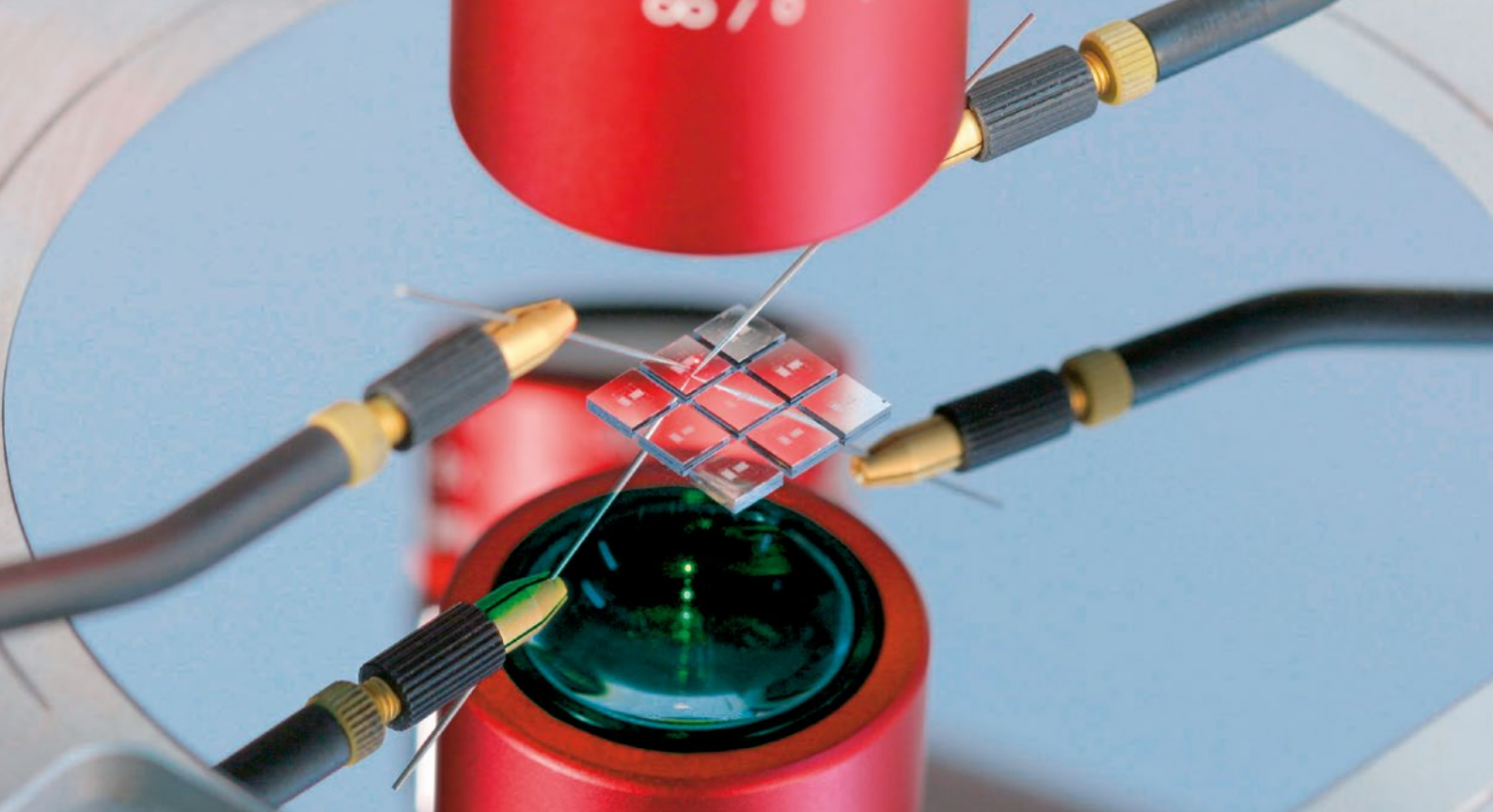



Measuring 3D dynamics and topography of MEMS and microsystems

Visualization of dynamic response and static characterization are key to testing and developing MEMS devices. They are important for validating FE calculations, determining crosstalk effects and measuring surface deformation.

The MSA-600 Micro System Analyzer is the all-in-one optical measurement workstation for characterizing surface topography as well as in-plane and out-of-plane motions. This instrument delivers measurement flexibility and precision, adapting to the testing needs of today's and tomorrow's microstructures.

The Micro System Analyzer provides 3D topography and dynamic response data useful for improving device performance while reducing development and manufacturing costs. This shortens design cycles, simplifies troubleshooting and improves yield.



Highlights

- All-in-one microscope-based measurement workstation for microstructures
- True real-time response measurement (no post-processing required)
- Unparalleled sub-picometer displacement resolution
- Fast measurement and visualization of deflection shapes and topography
- Straightforward operation with results that are intuitive and easy to interpret
- Automated system that integrates well for production (full probe station compatibility)

The all-in-one solution

Polytec's MSA-600 Micro System Analyzer combines three highly sophisticated measuring techniques in one instrument. This provides comprehensive investigation of microstructures in a single workstation.

- **Real-time vibration analysis**

Real-time characterization of out-of-plane (OOP) vibrations by laser Doppler vibrometry to frequencies up to 25 MHz and with a displacement resolution down to the (sub-)picometer level

- **Planar motion analysis**

Characterization and live-mode visualization of in-plane motion by stroboscopic video microscopy to frequencies up to 2.5 MHz and with a displacement resolution in the nanometer range

- **Surface topography analysis**

Surface topography measurement by scanning white-light interferometry provides a vertical resolution down to sub-nanometer and a horizontal resolution in the sub-micrometer range

01 **Real-time vibration analysis**

identify, measure and visualize system resonances and transient responses

02 **Planar motion analysis**

get detailed information about amplitude and phase

03 **Surface topography analysis**

obtain 3D profiles and determine surface and form parameters

Award winning technology

Polytec's MSA technology became the acknowledged worldwide standard for measuring and characterizing MEMS dynamics and topography. Used in the leading R&D labs around the world, Polytec's MSA system was recognized several times by prestigious awards like the German Sensor Innovation Award and the Photonics Circle of Excellence Award for the development and advancement of microscope-based scanning vibrometry.

Advancing microsystems of tomorrow

■ Simplify model validation

Validate and refine your FE simulations using highly precise experimental data. Laser Doppler vibrometers are established tools for quickly and reliably measuring the mechanical response of MEMS devices to electrical and physical stimuli. Non-contact optical measurement avoids any influence on the structure. Broadband measurement provides frequency response and transfer functions with excellent amplitude resolution.

■ Optimize MEMS functionality

Measuring the real-time response behavior of a device allows to optimize operation and reliability. For example, damping is a critical measurement task for determining the performance of micro mirrors. Real-time response measurements can be made using the MSA-600's time domain option to characterize the actuation dynamics of the mirror when switched from one tilt state to another.

■ Improve manufacturing process

The development of a new MEMS typically requires specifically improved production processes. Use the MSA-600 to evaluate current processes and their impact on device parameters such as dimensions, mechanical and material properties. This in turn will allow to better control the manufacturing process. For instance, topographic analysis is critical for building three-dimensional surface micro-machined sensors and actuators using Silicon-on-Insulator (SOI) technology. Measurements can be performed on wafer-level prior to packaging.



Your MSA benefits for R&D and production applications

- Rapid identification and visualization of both system resonances and static topography
- Integrated optimized microscope for best lateral resolution and highest image quality
- Easy integration with MEMS/wafer probe stations
- Simple and intuitive operation, ready to measure in a few minutes
- Increased productivity through a short measurement cycle
- Accelerates product development, troubleshooting and time-to-market

■ Test MEMS reliability and service life

Verification of safety-related functions of new MEMS components needs to take place under exact conditions. Vacuum and climate chambers are used to simulate the pressure loading and air humidity influences when mechanical excitation or other stimuli are applied. The long time function stability is verified in accelerated aging tests. Special long-distance lenses enable measuring from outside a test chamber.

■ Sort MEMS for critical applications

Stress on the membrane of a MEMS pressure sensor can adversely affect the expected lifetime of the device. Since stress shifts the vibrational resonance frequencies, devices that require a long lifetime can be selected from production runs by examination of their dynamic spectrum.



Real-time vibration analysis

Scanning laser Doppler vibrometry (SLDV) provides non-contact, real-time measurements of velocity and displacement on a grid of selected measurement points. This allows characterization of out-of-plane vibrational behavior. Unique features include the ability to acquire data with (sub-)picometer displacement resolution, to capture frequency response up to 25 MHz, and to analyze non-linear systems.

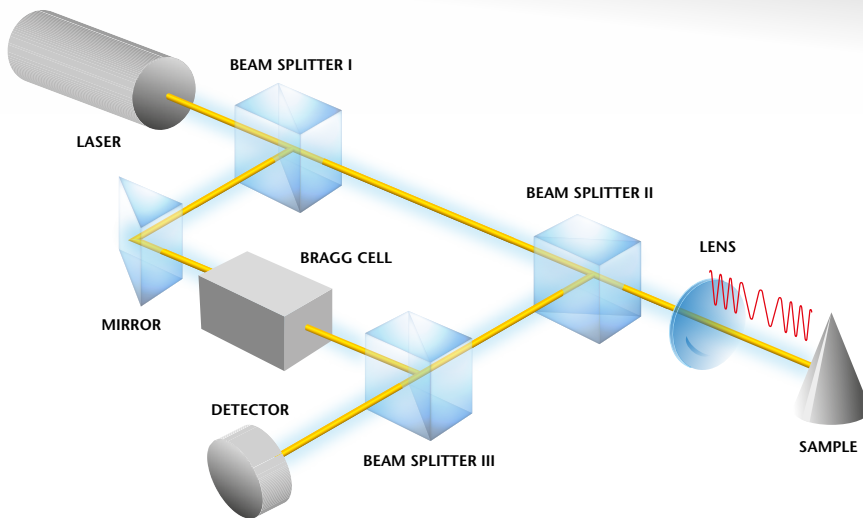

Highlights

- Dynamic response (vibration) measurement of velocity and/or displacement
- Full-field vibration mapping and broadband, out-of-plane frequency response information for intuitive results
- True real-time response measurement – can measure transient response and FRF transfer function
- Time domain animation for wave propagation measurements resolved down to sub-microsecond time scale
- Unparalleled (sub-)picometer displacement resolution for high accuracy measurements
- Differential option for relative motion analysis and external noise elimination

Measurement principle and optical setup of laser Doppler vibrometry (LDV)

How it works

The laser Doppler vibrometer (LDV) is a precision optical transducer for measuring the vibration velocity and displacement at a measurement point. It works by sensing the frequency and phase shift of back scattered light

from a moving surface. The object scatters or reflects light from the laser beam and the Doppler frequency shift is used to measure the component of velocity which lies along the axis of the laser beam.

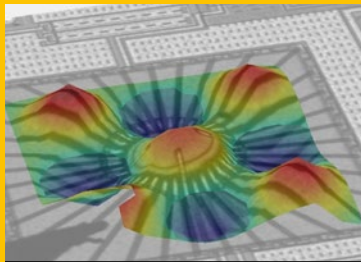

Deflection shape of MEMS IR sensor (Melexis)

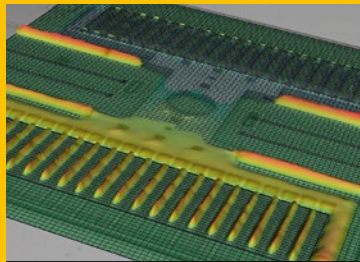

Electrostatic combdrive (SNL)

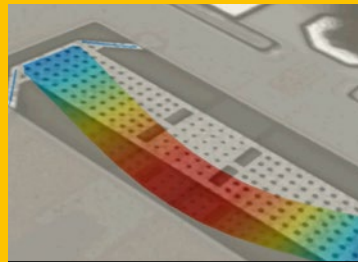

Time domain visualization of RF-MEMS-SWITCH (IHP)

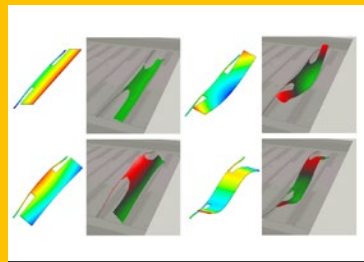

FE model validation by LDV (FHG ENAS)

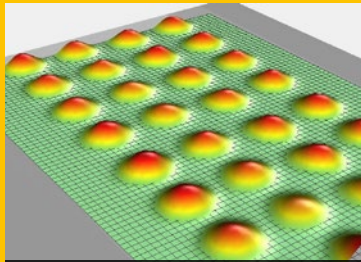

Deflection shape of CMUT array (University of Alberta)

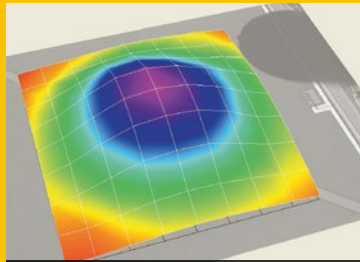

MEMS membrane pressure sensor

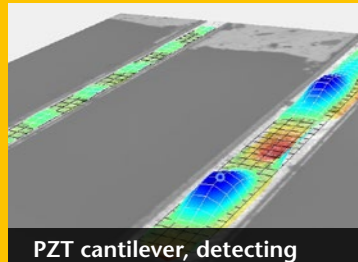

PZT cantilever, detecting 240 fm resonance amplitude at 17.8 MHz

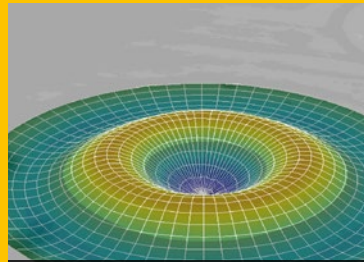

PMUT, higher order vibration mode (UC Davis)

Intuitive and powerful data analysis and evaluation

Our built in signal analysis software provides frequency response over the entire frequency bandwidth without the need to know the resonance frequencies in advance. The intuitive software package provides a built in signal generator to drive the device using a wide range of excitation wave forms, and the ability to analyze time

domain, FFT, Zoom FFT, averaged and peak hold data. Operational Deflection shapes (ODS) are visualized as impressive full field, 3D animations from the frequency response function (FRF) data. An open programming interface, versatile data export and a powerful built-in signal processor provides enhanced post-processing capabilities.

02 Planar motion analysis

Stroboscopic video microscopy provides a powerful method for the measurement and true motion visualization of the in-plane dynamics of microstructures. To precisely measure the planar motion of the device under test, a combination of stroboscopic illumination, digital imaging and pattern tracking is applied. Thus motions of fast moving objects can be sharply frozen in time to capture and track the exact position of a region of interest (ROI) on the specimen.

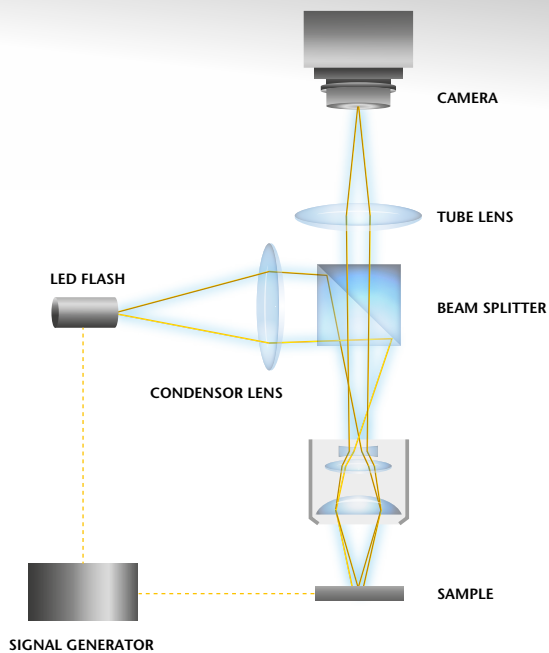

Measurement principle and optical setup of stroboscopic video-microscopy

How it works

Stroboscopic video microscopy for in-plane motion detection employs a special kind of stroboscopic technique: short light pulses synchronized with the objects motion capture the position at precise instants of time (phase angles). During the illumination time the motion is frozen. By shifting the timing of these pulses

by set increments, the motion of a moving object can be sampled and reconstructed. This procedure guarantees a high degree of measurement accuracy and a visual real-time analysis in live mode. The system is set to operate on predefined frequency bands selected from out-of-plane vibration measurements.



Highlights

- Easily measure and visualize in-plane motions
- Extract displacement amplitudes, system resonances, transient responses, phase variations and more
- True motion HD video shows real behavior of the structure
- Integration with laser Doppler vibrometry for rapid identification of resonances and band data transfer
- 5 nm displacement resolution, bandwidth up to 2.5 MHz, multi-band measurement
- Differential measurement comparing different areas of interest

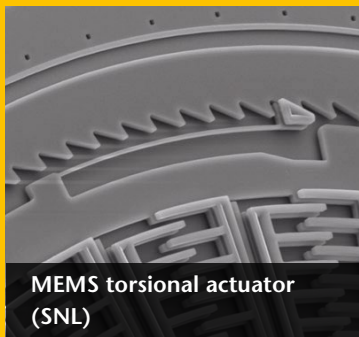

MEMS torsional actuator (SNL)

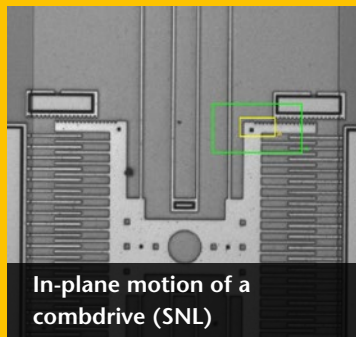

In-plane motion of a combdrive (SNL)

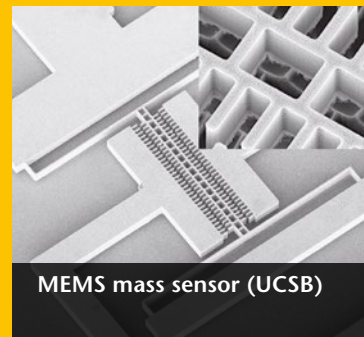

MEMS mass sensor (UCSB)

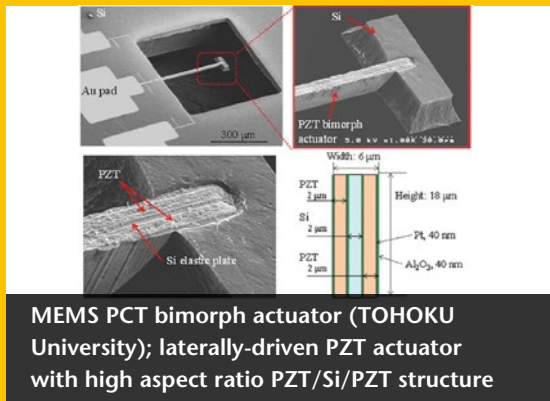

MEMS PCT bimorph actuator (TOHOKU University); laterally-driven PZT actuator with high aspect ratio PZT/Si/PZT structure

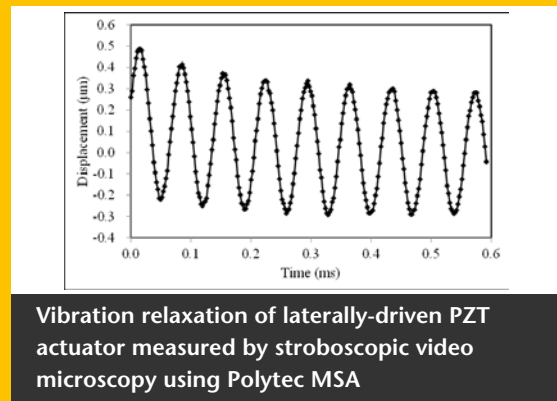

Vibration relaxation of laterally-driven PZT actuator measured by stroboscopic video microscopy using Polytec MSA

Laser Doppler vibrometry combined with in-plane stroboscopy

The combination of two complementary measurement techniques to investigate the vibrational behavior of small structures provides superior performance. The highly sensitive laser Doppler technique can rapidly find

all in-plane and out-of-plane resonances from broadband excitation. In a second step, the stroboscopic video microscopy technique is used to obtain accurate amplitude and phase information of in-plane resonances identified by laser vibrometry. Unknown resonance peaks can be found in a broadband frequency response spectrum without a time consuming search.



Surface topography analysis

When designing or manufacturing microsystems, structured surfaces require precise verification of surface topography to assure quality and performance. Due to its excellent spatial resolution the Micro System Analyzer's topography measurement unit is ideally suited for the 3D profile analysis of microstructures.

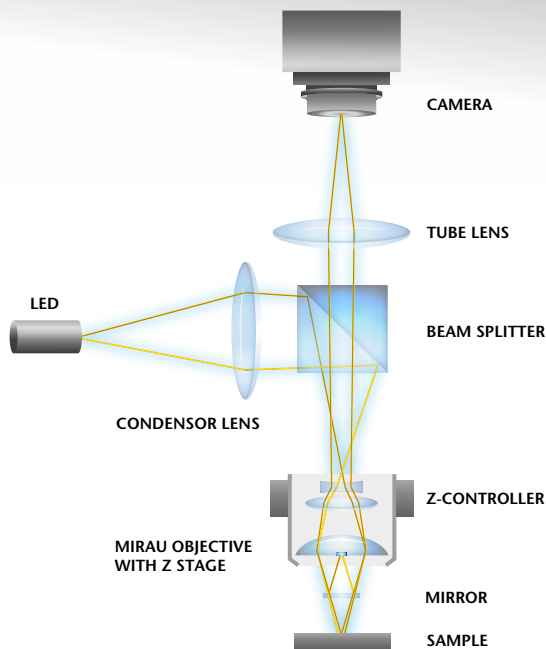

Highlights

- Analyze microstructures with excellent vertical and lateral resolution
- Rapid, non-contact 3D topography measurement on rough (scattering) or smooth (specular) surfaces
- 3D topography, flatness, waviness, roughness, geometry and texture parameter measurement
- Application-specific objectives for glass compensation and long working distances
- 2D and 3D presentation modes with video image overlay
- Smart Surface Scanning technique for best data quality on surfaces with different contrast levels

Measurement principle and optical setup of coherence scanning interferometry

How it works

The MSA Surface Topography Analysis is based on the principle of coherence scanning interferometry using a short coherence light source. Surface points with exactly the same distance to the internal beamsplitter as

the reference mirror will contribute to the interference signal at each camera pixel. Consequently, during a height scan the camera detects points of maximum interference and uses that as the height value. The MSA uses a special blue LED to obtain optimum height and lateral resolution.

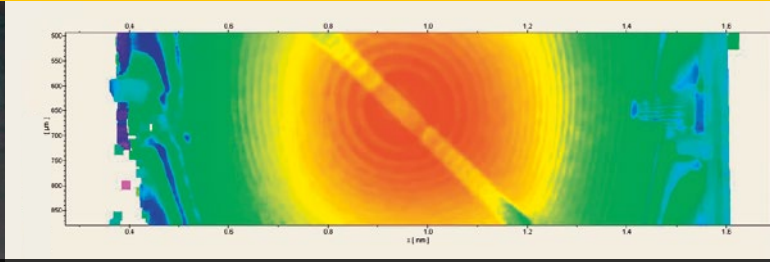
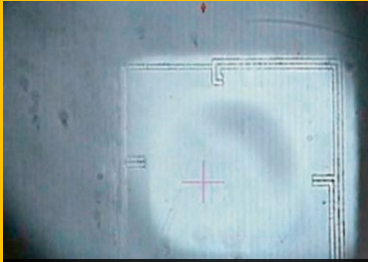

Topography of automotive pressure sensors (Melexis)



Measurement on a micro gearwheel (SNL)

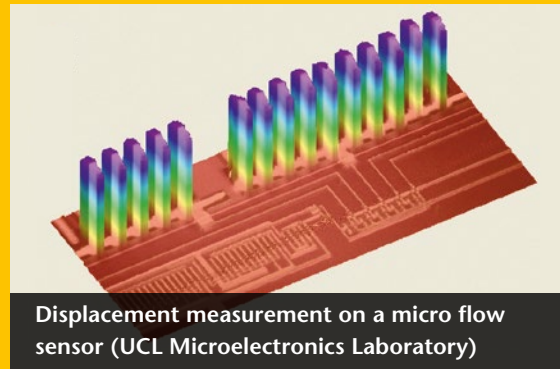

Displacement measurement on a micro flow sensor (UCL Microelectronics Laboratory)

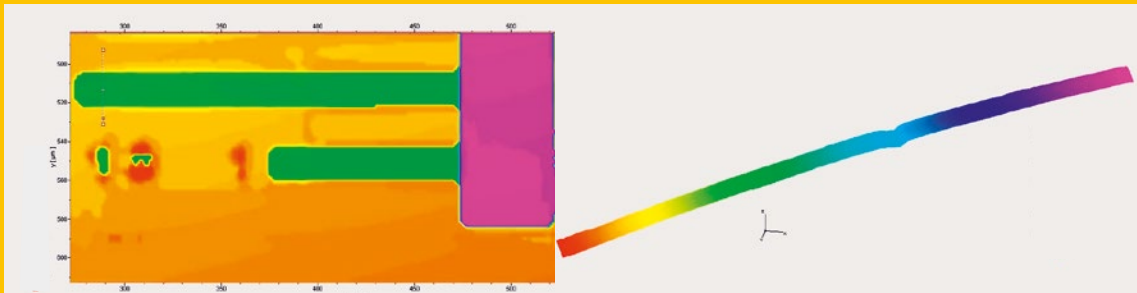

Surface topography and beam curl of a cantilever

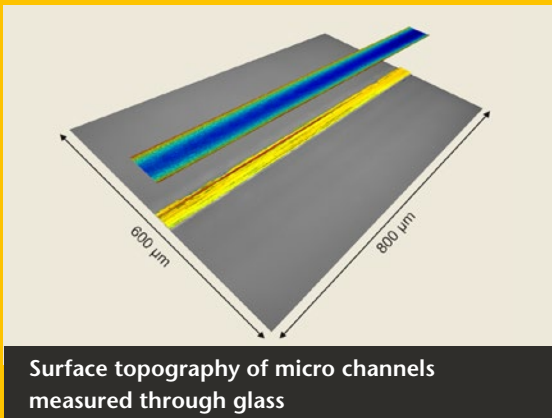

Surface topography of micro channels measured through glass

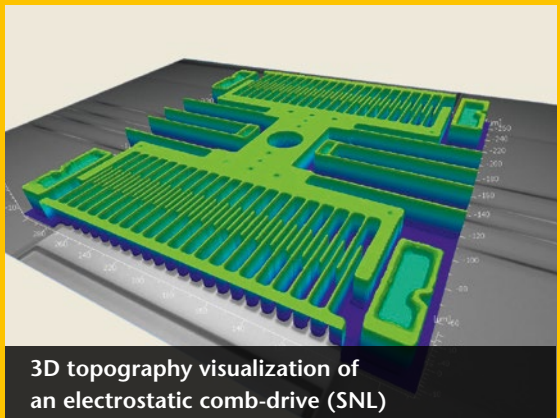

3D topography visualization of an electrostatic comb-drive (SNL)

The system and its parts

- 1 Base stand or portal stand
- 2 Sensor head
- 3 XY positioning stage
- 4 Analysis software
- 5 Front-end with controller and data management system



Flexible and upgradeable configurations

The main advantage of the MSA-600 is the “three-in-one” solution. The MSA-600 Micro System Analyzer can be configured with the combination of out-of-plane laser vibrometry, planar motion analysis or static topography as required for testing.

Whether single or combined tasks are needed, Polytec can provide the correct solution. For out-of-plane laser vibrometry, the system can be configured for either single beam or dual beam, differential operation. The differential systems provide an additional second reference beam to subtract out base or background motion. Both 2.5 MHz and 25 MHz versions of the system are available. Also, the systems can be later upgraded to add new capabilities when needed.

The MSA-600 electronics is typically mounted in a convenient 19” system cabinet that houses the front-end, controller, data management system and cabling. System cabinets reduce the influence of ambient noise by keeping the electronic components isolated from the work surface.

Optical accessories

Polytec offers a wide range of microscope lenses for topography analysis including Michelson and Mireau types. Special versions for long working distance and glass compensation lenses are available for measuring inside vacuum or pressure chambers.

System configuration

At the beginning, principally decide between single-ended or differential measurement (two laser beams e.g. for relative motion analysis and external noise elimination). The MSA-600 comes with a 2.5 MHz out-of-plane vibration measurement as standard configuration. Then, the modular approach offers upgrades exactly tailored to your testing needs: add bandwidth extension to 25 MHz, in-plane and surface topography options and stay flexible with a future-proof system.

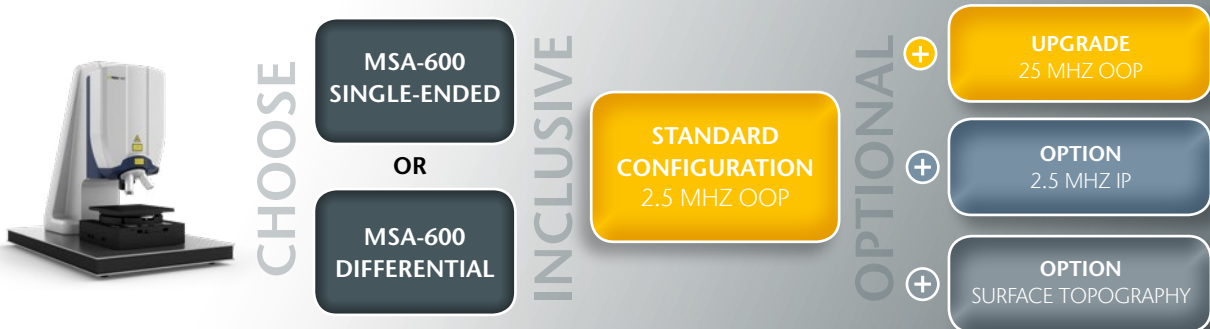

IP = in-plane
OOP = out-of-plane

Accessories tailored to your needs

Application-specific stand solutions

The MSA-600 Sensor Head can be mounted on Polytec test stands or commercially available probe stations. Polytec offers both manual and automatic focus versions of the test stand with integrated z stages. Polytec stands are available with vibration isolated workstations or can be installed on user supplied optical tables.

Automated sample positioning and measurement

Objects that are larger than the field view can be measured. An automated xy translation stage enables sequential measurements that are stitched together to create a larger field of view as in a single data set.

Please refer to the MSA-600 datasheet and to the accessory datasheet for stand-based systems for detailed technical specifications of the MSA-600 accessories.



Portal stand with motorized z-axis for supporting and focusing the sensor head



Base stand with manual z-axis on breadboard



XY positioning stage with tip-tilt unit for fine-adjustment of samples



Air-damped vibration isolation table with active level adjustment



Electronically controlled voice coil stabilization for highest isolation performance



Workstation to be used with Polytec's active vibration isolation tables

Probe station integration for wafer-level measurement

Wafer level testing requires the MSA measurement head to be combined with a probe station. Whether it's necessary to test devices prior to packaging or to perform routine quality control measurements directly on the wafer, the MSA-600 can be mounted onto virtually all commercially available wafer probe stations.

Wafer-level production quality control

While electrical test procedures are standard, optical measurements using the MSA-600 provide direct mechanical response of how the devices actual perform. The MSA-600 can be combined with a semi-automatic probe station to efficiently and quickly measure the dynamic behavior of all MEMS devices right on a wafer. That way, you can achieve a high throughput and

have a key tool for monitoring the production process. Wafer-level testing prior to chip separation allows the sorting out of bad dies early in the production process. This helps to keep MEMS production costs low while maintaining high yield and quality levels.

For example, the thickness of pressure sensor membranes can be determined by analyzing the membrane's frequency spectrum. Another example is the measurement of stress which affects the lifetime of the MEMS device, thereby allowing the qualification of the expected service life.

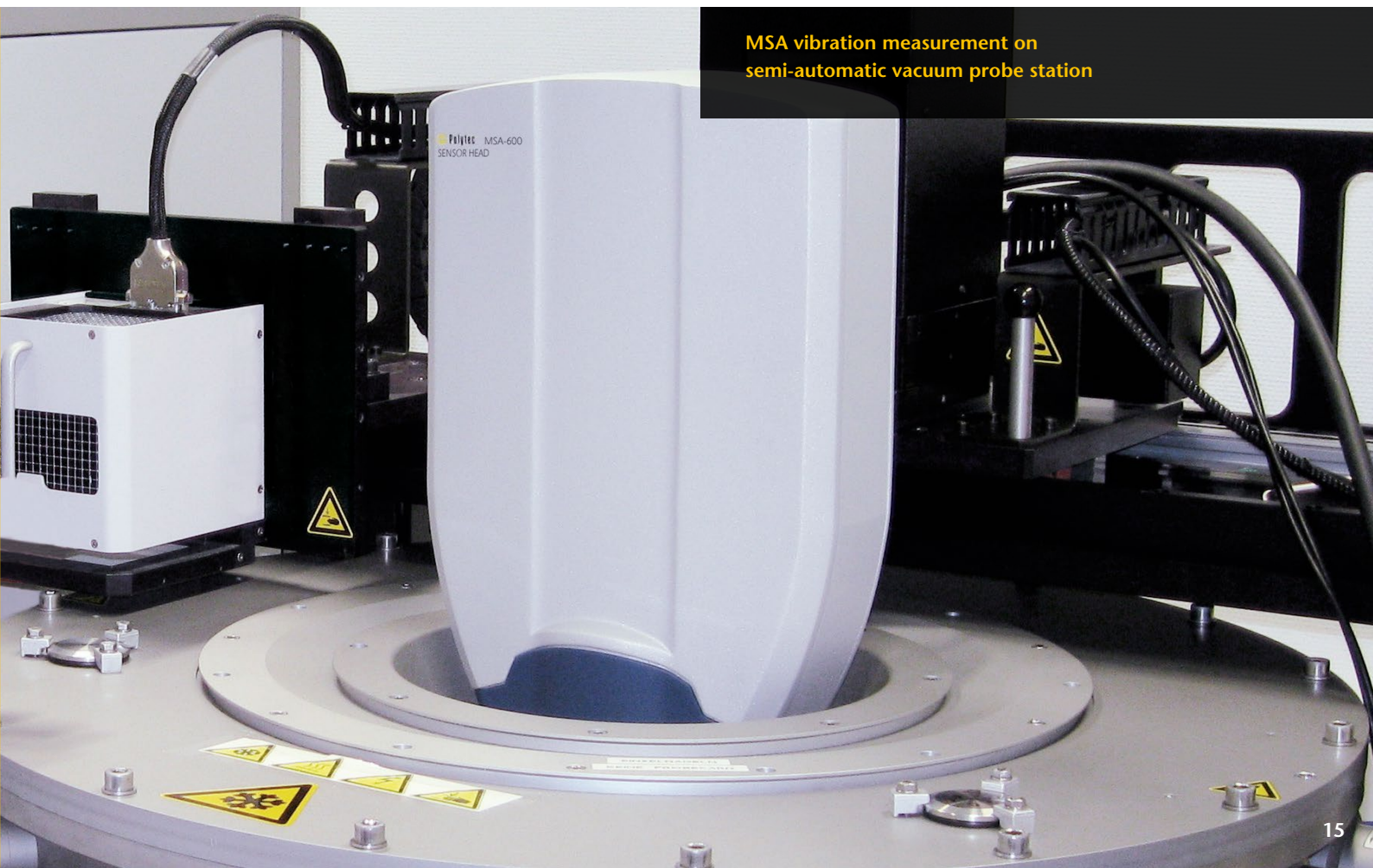

MSA vibration measurement on semi-automatic vacuum probe station

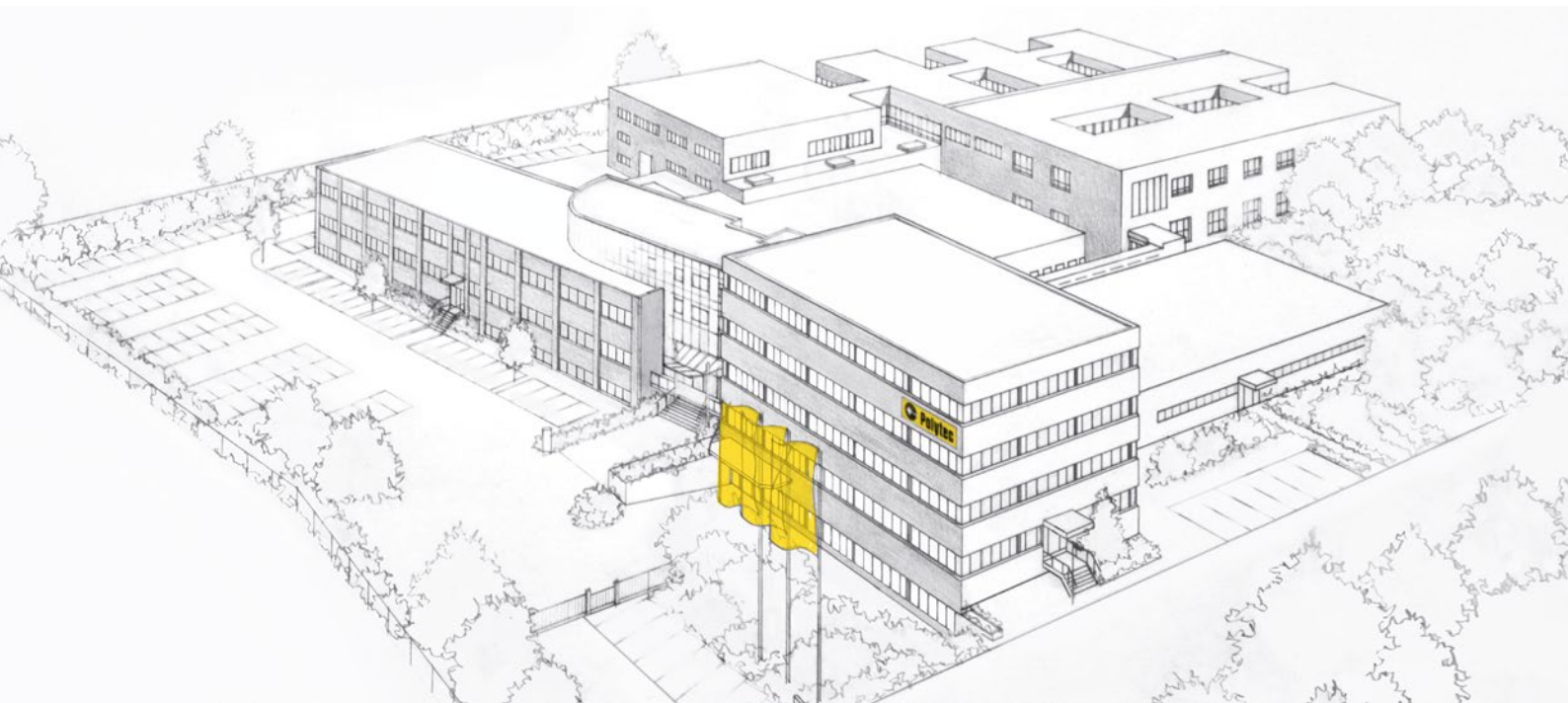

 **Polytec GmbH (Germany)**
Polytec-Platz 1-7
76337 Waldbronn
Tel. +49 7243 604-0
info@polytec.de

Polytec GmbH (Germany)
Vertriebs- und Beratungsbüro
Schwarzschildstraße 1
12489 Berlin
Tel. +49 30 6392-5140

 **Polytec, Inc. (USA)**
North American
Headquarters
16400 Bake Parkway
Suites 150 & 200
Irvine, CA 92618
Tel. +1 949 943-3033
info@polytec.com

Central Office
1046 Baker Road
Dexter, MI 48130
Tel. +1 734 253-9428

East Coast Office
1 Cabot Road
Suites 101 & 102
Hudson, MA 01749
Tel. +1 508 417-1040

 **Polytec Ltd. (Great Britain)**
Lambda House
Batford Mill
Harpenden, Herts AL5 5BZ
Tel. +44 1582 711670
info@polytec-ltd.co.uk

 **Polytec France S.A.S.**
Technosud II
Bâtiment A
99, Rue Pierre Semard
92320 Châtillon
Tel. +33 1 496569-00
info@polytec.fr

 **Polytec Japan**
Arena Tower, 13th floor
3-1-9, Shinyokohama
Kohoku-ku, Yokohama-shi
Kanagawa 222-0033
Tel. +81 45 478-6980
info@polytec.co.jp

 **Polytec South-East Asia Pte. Ltd.**
Blk 4010 Ang Mo Kio Ave 10
#06-06 TechPlace I
Singapore 569626
Tel. +65 64510886
info@polytec-sea.com

 **Polytec China Ltd.**
Room 402, Tower B
Minmetals Plaza
No. 5 Chaoyang North Ave
Dongcheng District
100010 Beijing
Tel. +86 10 65682591
info-cn@polytec.com